



PROCEEDINGS OF
THE PHYSIOLOGICAL SOCIETY

CAMBRIDGE MEETING

20–21 *September* 1968

DEMONSTRATIONS

The effect of sodium and calcium on the action potential of pregnant rat myometrium

By Y. ABE. *Department of Pharmacology, University of Oxford*

Spontaneous and evoked activity was recorded intracellularly in isolated rat myometrium between the 15th and 21st day of pregnancy.

When the sodium chloride of Krebs solution was replaced with sucrose, leaving 15 mM sodium present in the buffer, the spontaneous spike activity was transiently accelerated. Subsequently, the membrane became hyperpolarized and the frequency, the rate of rise and amplitude of the spontaneous spike gradually decreased, as previously reported (see Marshall, 1963; Csapo & Kuriyama, 1963). After about 30 min exposure to low sodium, the spontaneous activity became irregular and sometimes stopped. A spike could, however, always be evoked when a depolarizing current was applied. The rate of rise and the spike amplitude increased, and the half-duration of action potential decreased, until a steady state was reached. The maximum rate of rise was increased from 15.1 to 23.3 V/sec and the spike amplitude from 63.1 to 68.3 mV. The half-duration was decreased from 29.5 to 24.5 msec. Even after 3 hr exposure to low sodium larger and faster spikes could be observed. The size of the electrotonic potential evoked by externally applied hyperpolarizing current was unaltered in low sodium although the time constant was increased.

The effects of changing the external calcium concentration on the evoked action potential were essentially similar to those described on the spontaneous spike earlier (Csapo & Kuriyama, 1963; Marshall, 1965).

When the external calcium concentration (normal 2.5 mM) was raised to 5 mM, the membrane was hyperpolarized. The amplitude and rate of rise of spontaneous and evoked spikes were increased, and the half-duration became shorter. A higher calcium concentration (10 mM) produced little further change.

When the calcium concentration was reduced to 1.25, 0.625 mM or zero,

the membrane was depolarized and the spontaneous spike frequency increased temporarily. Gradually spontaneous activity slowed. The rate of rise and the amplitude of the spontaneous and the evoked spike declined and the half-duration was prolonged. Within 15 min of exposure to zero calcium the spontaneous activity ceased.

When the sodium and calcium concentrations were reduced simultaneously the effect of reducing calcium was less than in the presence of the normal sodium concentration (Marshall, 1965). In an external calcium concentration as low as 0.625 mM, the evoked spikes were larger and faster in low sodium than in normal sodium. Reduction of calcium to zero produced essentially the same effect in the presence of normal sodium and low sodium.

Tetrodotoxin (10^{-7} g/ml.) had no effect on the spike. Manganese (2 mM) depolarized the membrane and abolished spontaneous and evoked spikes within 5 min. Strontium (2.5 mM) slightly reduced the membrane potential, prolonged the spike duration, but did not abolish the spike.

The present experiments indicate that sodium may be involved in the generation of spontaneous activity and in the spread of excitation from cell to cell. However, sodium has little effect on the evoked action potential, while calcium appears to be essential for the spike mechanism.

REFERENCES

- CSAPO, I. A. & KURIYAMA, H. A. (1963). *J. Physiol.* **165**, 575–592.
MARSHALL, J. M. (1963). *Am. J. Physiol.* **204**, 732–738.
MARSHALL, J. M. (1965). *Muscle*, pp. 229–238. Oxford: Pergamon Press.

The effect of the tetraethylammonium ion on the inwardly rectifying potassium channel of frog sartorius muscle

By P. R. STANFIELD.* *Physiological Laboratory, Cambridge*

The tetraethylammonium (TEA) ion is known to inhibit delayed rectification in many nerve and muscle fibres. But the finding (Hagiwara & Watanabe, 1955; Washio & Mashima, 1963) that TEA may increase the membrane resistance of toad or frog skeletal muscle fibres suggests that in such preparations this quaternary ammonium ion has some other effect on the membrane conductance. Kao & Stanfield (unpublished observations), studying the effect of TEA iodide on the membrane resistance, came to the conclusion that TEA reduces the potassium conductance of the resting membrane.

The results of three types of experiment, performed to examine further this possibility in frog sartorius muscle fibres, were demonstrated.

* Medical Research Council Scholar. Present address: The Laboratory, Citadel Hill, Plymouth, Devon.

(i) Using the three electrode voltage clamp technique of Adrian, Chandler & Hodgkin (1966), TEA chloride, applied in a number of concentrations, was shown to reduce the amplitude of the slow creep in current, obtained when long hyperpolarizing pulses are applied to the fibre membrane, with little effect on the creep time constant. 115 mM TEA reduced the amplitude of the current change by 84 % and increased the membrane resistance of the fibre (measured at 500 msec) about 1.6 times from $3530 \Omega \text{ cm}^2$ to $5790 \Omega \text{ cm}^2$. (The calculation of the membrane resistance assumed a fibre diameter of 80μ and an internal resistivity of $250 \Omega \text{ cm}$.)

(ii) In the presence of a Ringer containing 50 mM potassium sulphate, the current flowing through the inward rectifier was reduced by 88 % when 150 mM TEA replaced a similar concentration of sodium. This effect was shown to be reversible.

The reductions in creep amplitude (i) and in the current flowing through the inward rectifier measured in high K (ii) fit, fairly closely, a concentration-effect curve for TEA with a dissociation constant of $2.3 \times 10^{-2} \text{ M}$.

(iii) When the external potassium concentration was increased from 2.5 to 10 mM at a constant chloride concentration of 120 mM in the presence of TEA (115 or 107.5 mM) the initial change in membrane potential was smaller than in the absence of TEA. Similarly, when the potassium concentration was returned to 2.5 mM, the initial recovery was small, and the subsequent recovery slower in the presence of the quaternary ammonium ion.

The experiments indicate that TEA inhibits the inwardly rectifying potassium channel of frog sartorius muscle fibres.

REFERENCES

- ADRIAN, R. H., CHANDLER, W. K. & HODGKIN, A. L. (1966). *J. Physiol.* **186**, 51-52P.
HAGIWARA, S. & WATANABE, A. (1955). *J. Physiol.* **129**, 513-527.
WASHIO, H. & MASHIMA, H. (1963). *Jap. J. Physiol.* **13**, 617-629.

Support of isolated lungs in a fluidized bed

By R. C. SCHROTER and M. F. SUDLOW. *Physiological Flow Studies Unit, Imperial College, London, S.W. 7*

In studies of regional ventilation and gas exchange in isolated lung preparations, it is essential to support the lungs with the correct geometric configuration, and attempt to reproduce the physiological external hydrostatic pressure gradient. Usually lungs are supported in air with subsidiary suspension of the lobes. Zardini & West (1966) suspended single isolated dog lungs in mixtures of egg albumin and air, thus providing buoyancy.

Their pressure-volume results were similar to those obtained in intact animals. Foams were, however, unstable over long periods.

The present technique, as demonstrated, may be more suitable for the support of isolated preparations for studies of lung function. Lungs, suspended by the trachea and ventilated by positive pressure from a B.O.C. respirator, are immersed in a 'fluidized bed'.

A fluidized bed is a deep bed of solid particles (in this case slightly expanded polystyrene beads approximately 1 mm diameter) through which passes a uniform upcurrent of air (approximately 10 cm/sec). Under such conditions the mass behaves just as a liquid composed of very large 'molecules' with a bulk density of approximately 0.2 g/ml. The buoyancy exerted by the fluid on the lungs provides nearly neutral density support and a similar gradient of pleural pressure down the lung to that obtained in the intact condition. The bed is 6.3 ft.² in cross-section and 2 ft. deep—this large size compared with the lungs prevents any wall effects and resultant bad support. To prevent the polystyrene beads from sticking to the surface of the lungs—which are inherently wet—they were placed inside a very thin gauge polythene bag before immersion in the bed. The polythene bag did not affect the relative movements of the lobes when the lungs were simply supported in air.

To ascertain the attitude taken up by the lungs when suspended in the bed, posterior-anterior X-ray photographs have been taken. The angle between the main bronchi at the carina has been measured and found to be over 50° for human post mortem lungs. This compares with an angle of 20° for the same lungs when suspended in air. The normal angle at the carina as measured from bronchograms varies from approximately 65° to 80°.

The technique is still being developed and it is hoped that, as well as providing a time stable supporting medium, it will be possible to provide an even closer simulation of the *in vivo* lung configuration.

This work was supported by grants from the Tobacco Research Council, the Asthma Research Council and the Wates Foundation.

REFERENCE

ZARDINI, P. & WEST, J. B. (1966). *J. appl. Physiol.* **21**, 794.

Electromyographic and cinematographic analysis of spinal extension under stress

By H. DAVID, E. J. HAMLEY and G. R. SAUNDERS. *Department of Ergonomics, University of Loughborough, Leics.*

The demonstration outlined a technique used to investigate the activity of erectores spinae (sacro-spinalis) relative to the changing mechanical

advantages in which their contraction is exerted during spinal extension in straight legged weight lifting.

Synchronization of electromyographic and cinematographic recordings and mathematical analysis of the data permits a comprehensive study of body mechanics in conditions of stress. Reference points make it possible to isolate the exact cine frame at which calculated means of the onset and decline of the major levels of contractile activity occur. The spinal configurations at these and other points were derived from the film with the aid of pointers attached over the spinous processes, and the nature of the component parts of the spinal curvatures were analysed by computer techniques.

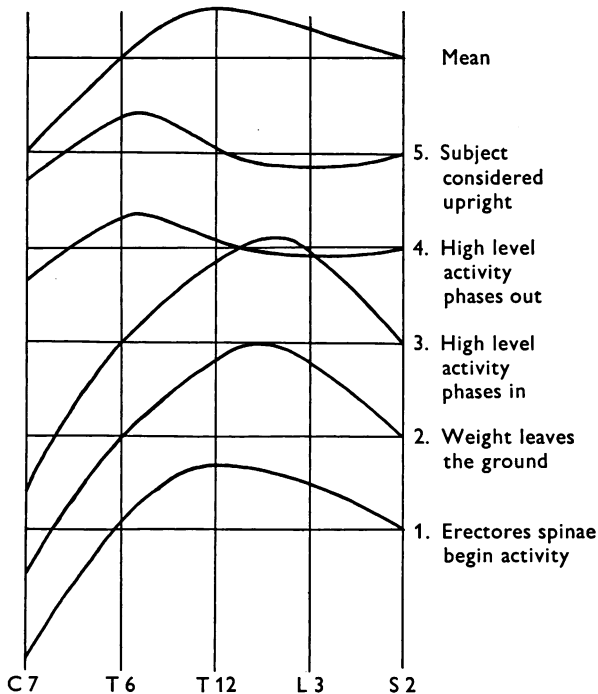

Fig. 1. Individual representations of the means of the mathematically derived spinal configurations at the points of interest—drawn to scale.

During the early stages of movement before the weight leaves the ground and whilst erector spinae contraction is shown by electromyography to be low level or silent, great stresses have been calculated to occur in the lower part of the spine (Bradford & Spurling, 1945), but the validity of such calculations is questionable unless considered in conjunction with postural reaction to the stress, and the level of intra-truncal pressure reached.

The results indicate three points:

- (1) Initial movement of extension is in fact flexion.

(2) There is a shift in the point of maximum spinal curvature from the region of T 11 to the region of L 2 as illustrated in Fig. 1. The point of stress that would potentiate weakness and allow injury can be seen to move with the point of maximum curvature of the spinal column.

(3) The lumbosacral joint may be considered fixed relative to the rest of the spine and is therefore a fulcrum of spinal movement. Figure 2 shows that the mean curves for the spinal configurations derived for each subject pass through or very close to the point representing T 6. During extension

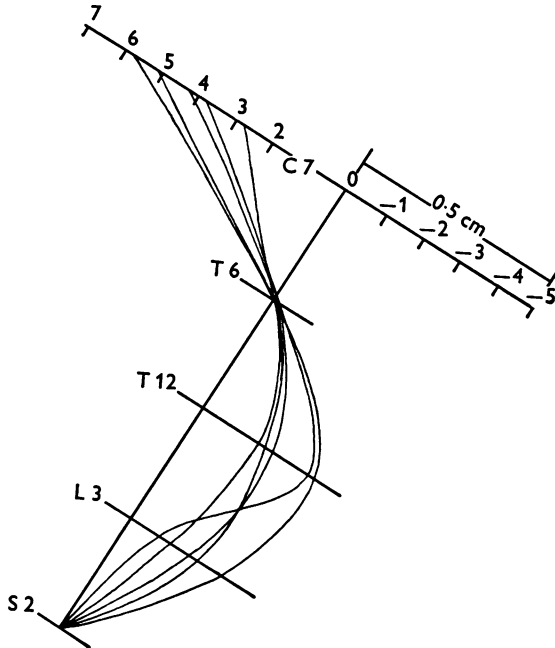

Fig. 2. A selection of mean spinal configurations from five subjects. 0.5 cm. scale size = 5 cm. actual.

this point remains equidistant from the sacrum and is therefore fixed in space relative to it. T 6 may be considered as another fulcrum of spinal movement. Curvature occurring between T 6 and the lumbosacral junction can be seen to be greatest at the thoraco-lumbar junction. Since extreme forces involved in stoop lifting operate at this weak link, injury is potentiated.

It would seem logical to suggest that any attempt to lift heavy loads should be stopped immediately if the hips cannot be kept below the level of the upper body as the legs extend.

REFERENCE

- BRADFORD, F. K. & SPURLING, R. G. (1945). *The Intervertebral Disc*. Springfield, Illinois: Charles C. Thomas.

Method of localizing end-plates in unstained frozen muscle

By R. CREESE, J. M. ENGLAND and D. B. TAYLOR.* *Department of Physiology, St Mary's Hospital Medical School, London, W. 2 and * Department of Pharmacology, University of California School of Medicine, Los Angeles, California 90024*

Diaphragm muscles of rats and mice were frozen on solid carbon dioxide during the course of experiments on the distribution of labelled depolarizing drugs in muscle. It was found that an irregular white line became apparent in the frozen diaphragm, and that this white line corresponded to the band of end-plates which can be demonstrated by histochemical staining (Hebb, Krnjević & Silver, 1964). The irregular white line can be seen in Fig. 1, which shows a frozen diaphragm of a mouse. Similar results have been obtained in rat diaphragm, latissimus dorsi and epitrochlearis muscles.

In this demonstration the muscles were attached to brass plates and frozen on blocks of solid carbon dioxide under plastic covers. The white line becomes visible as soon as the diaphragm freezes, and can be distinguished from the intramuscular branch of the phrenic nerve. The appearance of the white line depends on the rate of cooling, and is not seen if the tissue is rapidly frozen in isopentane chilled in liquid nitrogen—a procedure which would be expected to diminish the formation of ice crystals (Luyet, 1960; Pearse, 1960).

The uptake of decamethonium-³H dichloride has been studied in rat muscle. One hour after intravenous injection of the labelled compound the muscles were removed and frozen and the radioactivity in strips of tissue 1 mm wide was measured (Taylor, Creese, Nedergaard & Case, 1965). It was found in the case of diaphragm, latissimus dorsi and epitrochlearis that the peak of uptake corresponded to the white line seen in the frozen tissue.

This research was supported by grants from the Medical Research Council and by U.S. Public Health Service Grant NB-00738.

REFERENCES

- HEBB, C. O., KRnjević, K. & SILVER, A. (1964). *J. Physiol.* **171**, 506-513.
 LUYET, B. (1960). *Ann. N.Y. Acad. Sci.* **85**, 549-569.
 PEARSE, A. G. E. (1960). *Histochemistry, Theoretical and Applied*, pp. 28-30. London: Churchill.
 TAYLOR, D. B., CREESE, R., NEDERGAARD, O. A. & CASE, R. (1965). *Nature, Lond.* **208**, 901-902.

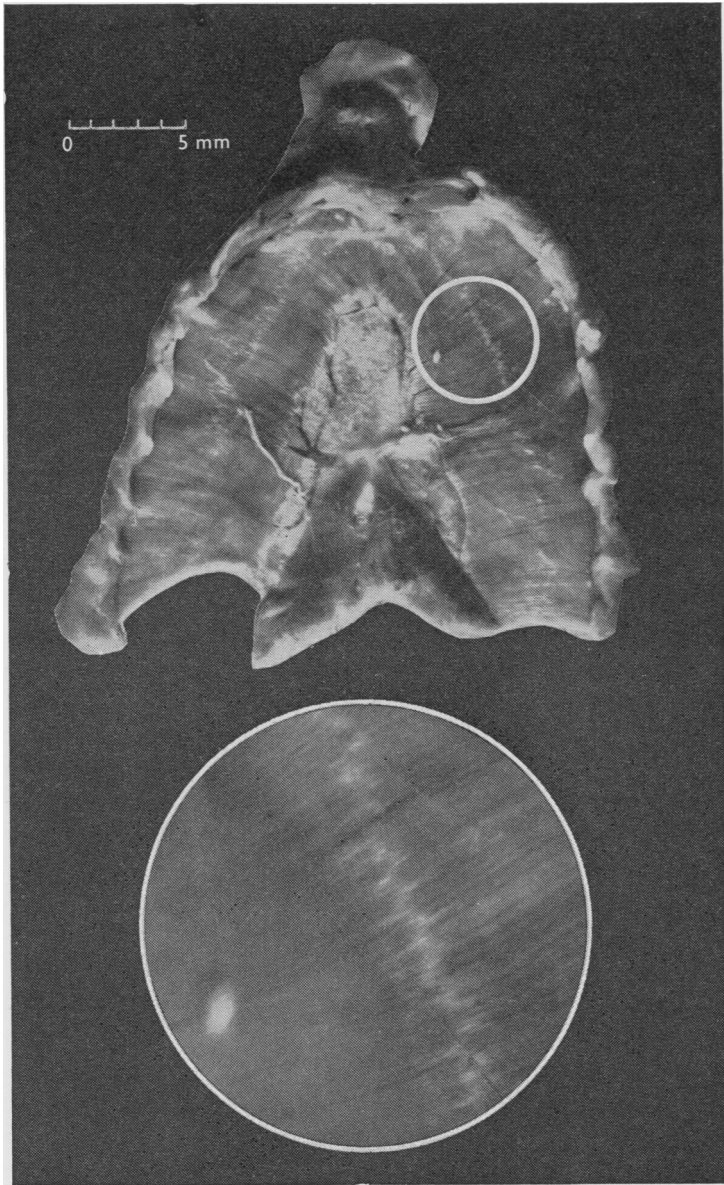

Fig. 1. Mouse diaphragm frozen on solid carbon dioxide. The irregular pale line corresponds to the band of end-plates. The lower photograph shows the encircled area at a higher magnification.

The action potentials recorded from undamaged nerve fibres with micro-electrodes

By G. F. COOPER, J. G. ROBSON and INGRID WALDRON. *Physiological Laboratory, Cambridge*

Action potentials recorded from an undamaged nerve fibre in a volume conductor should be triphasic in form; a micro-electrode near the nerve fibre should become successively positive, negative and then positive again with respect to a remote electrode. Although such potentials have been recorded regularly by Maturana, Lettvin, McCulloch & Pitts (1959) in the optic nerve and tectum of the frog, many investigators appear to have seen only slower diphasic potentials that may come from damaged fibres in which conduction is blocked near the micro-electrode.

We have recorded brief triphasic potentials from the optic tract and other sites in the C.N.S. of several mammals. We have used metal-filled glass micropipettes with electrolytically deposited tips of platinum black about 3-4 μ in diameter, or flame-sharpened tungsten wires fixed into glass micropipettes with exposed tips about 10 μ long and 3 μ in diameter. Since the duration of the main phase of these triphasic action potentials is rather short it is necessary to employ a recording system with a large bandwidth; this can only be achieved if the input capacitance of the preamplifier is low. Because of the large bandwidth the noise level is high. Furthermore, little of the energy in the brief triphasic action potentials is in the lower audible frequency range. So it is usually impossible to hear the potentials in the unprocessed signal. In order to observe the exact form of the potentials we have used a digital averaging computer (Biomac 1000). Since the action potentials we have studied arose either spontaneously, or irregularly in response to natural stimulation, we have had to use the main phase of the action potential itself (usually about twice the peak noise voltage in amplitude) to trigger the sweep of the averaging device. In order to retain the earlier part of the action potential we have used a passive LC delay line with 40 sections to delay the signal to be averaged by 80 μ sec. The over-all bandwidth of the recording system extended from 200 Hz to 60 kHz.

A typical brief triphasic action potential recorded from the cat's visual cortex is shown in Fig. 1*a* and the action potential of an optic tract fibre is shown in Fig. 1*b*. There can be little doubt that the potentials recorded in the cat's optic tract originated from myelinated fibres since these are the only structures present (P. R. Lewis, personal communication). It is likely that the majority of the triphasic potentials that we have recorded in the visual cortex came from geniculostriate fibres, since the response characteristics were like those of geniculate cells (fairly high resting dis-

charges, no orientation selectivity) rather than cortical cells. A few cortical units showing orientation-selectivity have also had brief triphasic action potentials; these probably came from the axons of cortical cells. Similar brief triphasic action potentials have also been recorded from optic tract fibres of the squirrel and squirrel monkey and from units in the mid-brain, pons and medulla of the cat.

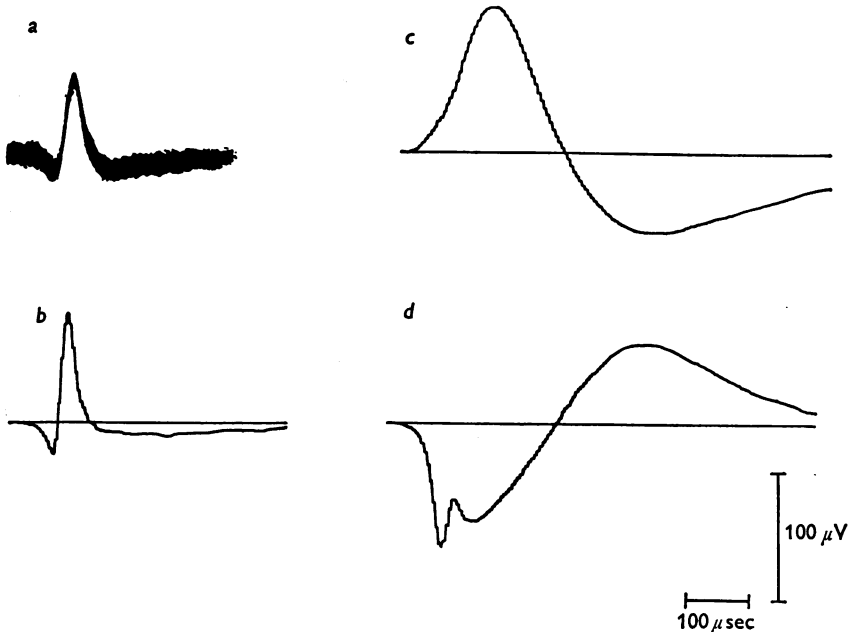

Fig. 1. Action potentials recorded in cat c.n.s. from (a) a geniculostriate fibre in the visual cortex (about 200 potentials superimposed), (b) an optic tract fibre, (c) a cell in the visual cortex, and (d) a damaged fibre. The records in (b), (c) and (d) are averages of 256 action potentials. Negativity is upwards.

The general form of these action potentials is remarkably constant. A short first positive phase is followed by a negative phase which is slightly longer in duration and several times greater in amplitude; this is followed in turn by a positive phase which lasts several times longer but is of somewhat lower amplitude than the first phase. The duration of the negative phase is 25–50 μsec at half height and 50–130 μsec between zero crossings. Brief negative action potentials (100 μsec) have been occasionally observed by Amassian, Macy, Waller, Leader & Swift (1962) in the cuneate nucleus. The brief triphasic action potentials can be readily distinguished from the typical action potentials of nerve cell bodies (Fig. 1c) which are diphasic, longer in duration and can be much greater in amplitude. Brief triphasic action potentials are relatively stable and may be

recorded for several hours under favourable conditions. Their amplitude, which is rarely greater than $150 \mu\text{V}$, may decline with time but terminal high-frequency injury discharges have never been observed.

A few action potentials recorded from nerve fibres do not have the typical triphasic form. Figure 1*d* shows an action potential recorded from the optic tract while withdrawing the micro-electrode; it is an example of the potentials which are recorded under circumstances in which it may reasonably be assumed that fibres have been damaged. These action potentials have a rather long initial positive phase and are generally diphasic though they are not very stable and their form often becomes more complex before they fail altogether.

The authors are in receipt of a grant from the M.R.C.

REFERENCES

- AMASSIAN, V. E., MACY, J. JR., WALLER, H. J., LEADER, H. S. & SWIFT, M. (1962). *Proc. of Internat. Union of Physiol. Sci.*, XXII Internat. Congress, Leiden, 3, 235-254.
- MATURANA, H. R., LETTVIN, J. Y. McCULLOCH, W. S. & PITTS, W. H. (1959). *J. gen. Physiol.* 43, suppl. 2, 129-176.

Adaptation to spatial stimuli

By C. BLAKEMORE and F. W. CAMPBELL. *The Physiological Laboratory, University of Cambridge*

It is well known that the visual system adapts to luminance, colour and movement. We have found that there is also adaptation to certain spatial stimuli. This phenomenon can readily be demonstrated.

If the reader views Fig. 1 from a distance of about 3 m he will see, in the centre, a person holding an umbrella. The superimposed low-contrast vertical grating represents the 'rain'. Now view, for about 60 sec, the high-contrast vertical grating of the same spatial frequency as the 'rain', in the upper left, by letting the point of fixation wander around the circle. (This eye movement is required to prevent an after-image of the grating developing.) After this adapting period fixate the person's head and it will be noted that the 'rain' has stopped, although it returns again after some seconds. Repeat the experiment but this time fixate the horizontal grating in the upper right. A negative result is obtained. This is also the case if either of the lower gratings, of very different spatial frequency to that of the 'rain', is viewed during the adapting period.

The phenomenon can be investigated quantitatively by displaying grating patterns on an oscilloscope (Campbell & Green, 1965) and measuring the threshold contrast to see a grating before and after adapting to a high-contrast grating of the same spatial frequency and orientation. Temporarily, there is about a fivefold rise in the threshold.

An identical adaptation effect can be demonstrated objectively by means of the visual evoked potential detected with electrodes placed on the occipital region. In this case, a grating is displaced repetitively, about five times per second, by half a grating cycle. The evoked response is summed by a computer of average transients. A substantial evoked potential can be obtained if the grating contrast is five times greater than the psychophysical contrast threshold. Immediately after the subject has viewed a similar grating of high contrast for about 30 sec no detectable evoked potential is generated by the test grating, although subsequently it slowly

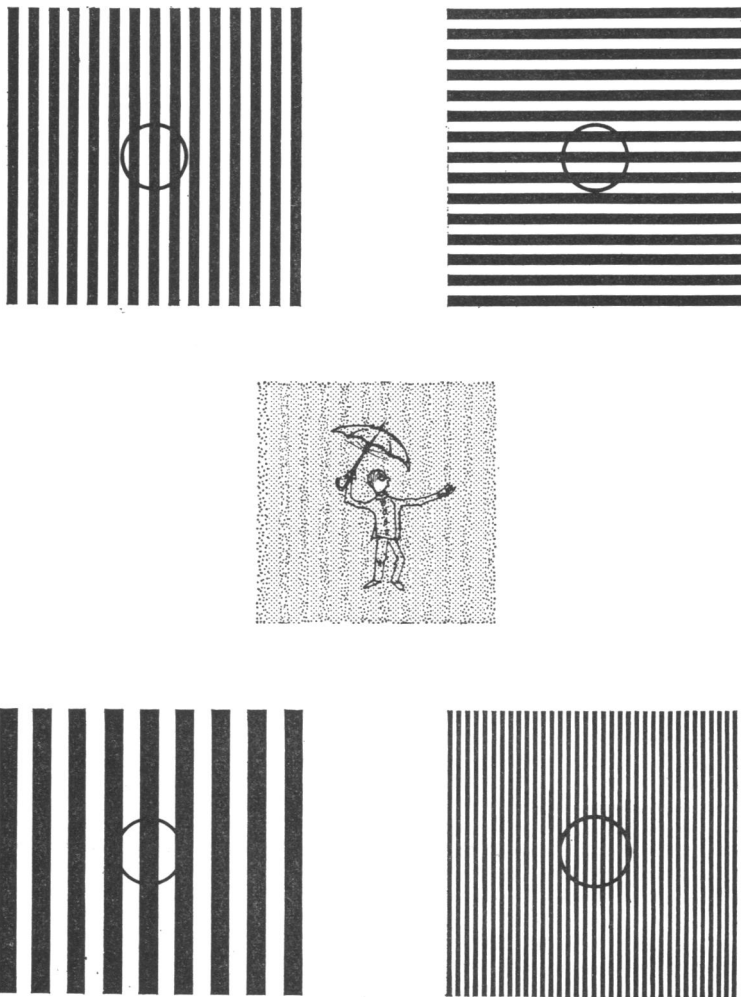

Fig. 1. Follow the instructions in the text to demonstrate the adaptation effect. The spatial frequencies of the coarse and the fine gratings differ by one octave from that of the 'rain'.

returns. Suppression of the evoked potential and elevation of the psychophysical contrast threshold for a test grating do not occur if the adapting grating has a substantially different orientation. Likewise, there is no effect if their spatial frequencies differ by more than about one octave.

The findings of Hubel & Wiesel (1962, 1968) suggest that the terminations of the geniculate fibres in the visual cortex of the cat and the monkey are not orientation specific and that the majority of cells in the visual cortex are very sensitive to orientation. Campbell, Cleland, Cooper & Enroth-Cugell (1968) have measured this orientation specificity quantitatively in the cat cortex and compared it with psychophysical measurements in man (Campbell & Kulikowsky, 1966). The finding that these adaptation effects upon the threshold contrast and the evoked potential for a grating are orientation-dependent provides further subjective and objective evidence that the visual cortex of man is similarly organized.

Campbell & Robson (1968) have proposed that in man there may be channels tuned to different ranges of spatial frequency. It should be possible to measure the characteristics of these channels both psychophysically and electrophysiologically using this adaptation effect.

REFERENCES

- CAMPBELL, F. W., CLELAND, B. G., COOPER, G. F. & CHRISTINA ENROTH-CUGELL (1968). *J. Physiol.* **198**, 237-250.
 CAMPBELL, F. W. & GREEN, D. G. (1965). *J. Physiol.* **181**, 576-593.
 CAMPBELL, F. W. & KULIKOWSKI, J. J. (1966). *J. Physiol.* **187**, 437-445.
 CAMPBELL, F. W. & ROBSON, J. G. (1968). *J. Physiol.* **197**, 551-566.
 HUBEL, D. H. & WIESEL, T. N. (1962). *J. Physiol.* **160**, 106-154.
 HUBEL, D. H. & WIESEL, T. N. (1968). *J. Physiol.* **195**, 215-243.

A versatile respiratory integrator

By C. B. MCKERROW and J. A. REYNOLDS. *M.R.C. Pneumoconiosis Research Unit, Llandough Hospital, Penarth, Glamorgan*

Screen pneumotachographs can offer a very low respiratory resistance which makes them attractive for many respiratory measurements. The recent availability of moderately priced 'Operational' amplifiers greatly facilitates the production of accurate and stable integrators to derive volume from flow.

The respiratory integrator demonstrated is an example of one with a wide range of applications (Fig. 1). Besides producing the conventional spirogram the apparatus permits the integration of individual inspirations and expirations with resetting to zero between each, and also the continuous integration of each inspiration or expiration in a succession of breaths; thus minute volume can be measured without the necessity of any

valves in the respiratory circuit. Lastly, a built-in timer and reset mechanism permits the measurement of volume inspired or expired over 6 periods ranging from 0.25 to 60 sec.

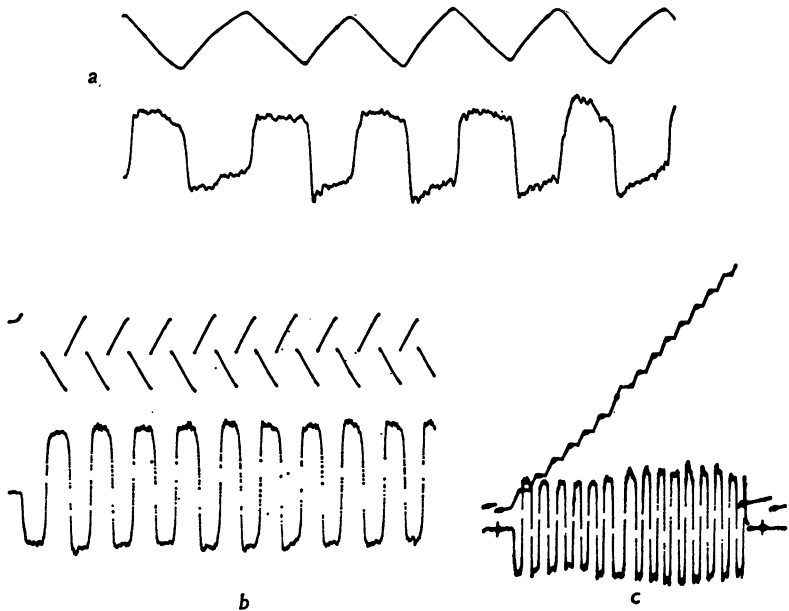

Fig. 1. Recorder tracings from instrument. (a) Conventional spirogram. (b) Automatic reset between individual inspirations and expirations. (c) Summation of inspirations.

A block diagram of the instrument is shown in Fig. 2. Three operational amplifiers marked A_1 , A_2 and A_3 are used. A_1 which is chopper stabilized has a gain of 10^7 and performs the integration. High quality components permit the integration of the input voltage with a measured error of less than 0.1%. The output of A_1 is displayed on a meter and there is also provision for permanent records with a suitable recorder. A reset circuit restores the integrator to zero on each full-scale reading and registers these on a digital counter.

A_2 forms part of the flow discriminating circuit to allow automatic resetting on each inspiration and expiration or summing of either inspiratory or expiratory breaths. The input to the integrator may be switched in for predetermined times, A_3 and its associated circuit forming a precision timer.

An input control allows different sensitivity pneumotachographs to be matched to the meter marked in litres; matching is very easily done using a standard rotameter with input to the integrator applied for a period set

by the timer. The accurate performance of integrator and recorder, if used, can be checked by an internal standard voltage.

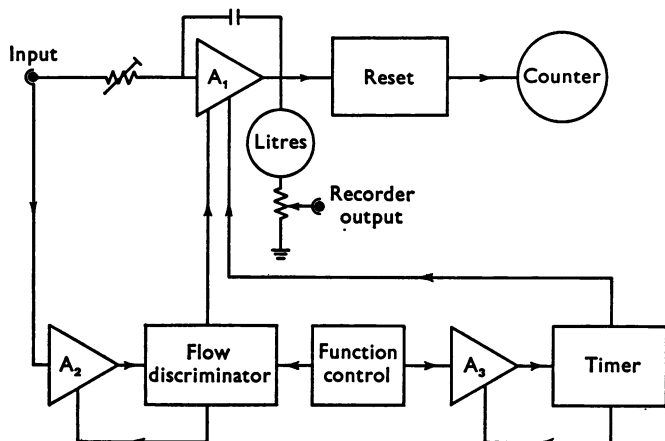

Fig. 2. Block diagram of the instrument.

The kinetics of mechanical activation in frog muscle

By R. H. ADRIAN, W. K. CHANDLER and A. L. HODGKIN. *Physiological Laboratory, University of Cambridge*

Muscular wisdom

By C. D. MARSDEN, J. C. MEADOWS and P. A. MERTON. *Physiological Laboratory, University of Cambridge*

Hypophysectomy of the foetal lamb

By R. S. COMLINE, I. A. SILVER and MARIAN SILVER. *Physiological Laboratory, Cambridge and Anatomy School, Cambridge*

Do-it-yourself micro-electronics

By P. E. K. DONALDSON. *Physiological Laboratory, Cambridge*

Zonal centrifugation of bovine spermatozoa on density gradients

By J. M. O'DONNELL. *A.R.C. Institute of Animal Physiology, Babraham, Cambridge*

Values obtained for the specific gravity of ejaculated bull spermatozoa have varied with the method of determination. Using as index of specific gravity the buoyant density in aqueous solutions of the methylglucamine salt of umbradilic acid, Lindahl & Kihlström (1952) reported a mean value of 1.28 g/ml. Benedict, Schumaker & Davies (1967) employing the same

compound as dense component in density gradients found two density classes of cells, at specific gravities 1.16–1.19 and 1.27–1.32 g/ml., when centrifuged to equilibrium. These media exerted large osmotic pressures at high concentration. In non-aqueous suspensions Lavon, Volcani, Amir & Danon (1966) found a mean value of 1.07, while for rabbit spermatozoa Beatty (1964), who carefully controlled pH and osmolarity, found a mean value of 1.13.

The influence of osmolarity and viscosity of a density gradient on buoyant density and hence on the sedimentation rate of cells was investigated by the technique of zonal centrifugation in a low-speed 'A' type zonal rotor. Untreated bull semen was slowly cooled and run at 0° C on various gradients for 90 min at 1000 rev/min. The gradient was fractionated into 50 ml. fractions which were counted for spermatozoa and monitored for specific gravity and viscosity at 20° C. Density gradients were made by mixing (1) an artificial bull seminal plasma and (2) a solution of dense component in the same medium. Addition of the heavy component to a chamber filled with light component generated a convex gradient which was pumped into the rotor as it was mixed.

Three gradient-forming materials have been investigated. In sucrose gradients a final specific gravity of 1.15 was attained, and spermatozoa were found at a position of modal specific gravity 1.13, viscosity 5 centipoises, after centrifuging as described. This solution exerted an osmotic pressure many times that of artificial seminal plasma. Gradients of specific gravity up to 1.06 were formed with both polyvinylpyrrolidone (PVP) and Ficoll. The osmotic pressure of the PVP gradient at the upper limit was much less than in sucrose of identical specific gravity, while with gradients employing dialysed Ficoll there was only a slight increase in osmolarity compared to artificial seminal plasma. The upper limit of viscosity was 20 cP in PVP and 7 cP in Ficoll. Spermatozoa spun in these gradients attained positions corresponding to specific gravities in the range 1.02–1.05. These results indicated that the lower viscosity of sucrose gradients was not responsible for the more rapid rate of sedimentation in sucrose than in the other solutions. In addition to the relatively enormous osmotic pressure of sucrose gradients there was also a significant decrease in the percentage of live cells recovered from sucrose gradients when compared to uncentrifuged spermatozoa. This effect was not observed with the other materials. Only single density classes of cells were found in all sedimentations.

REFERENCES

- BEATTY, R. A. (1964). *Proc 5th Int. Cong. Anim. Reprod., Trento* 3, 267–281.
BENEDICT, R. C., SCHUMAKER, V. N. & DAVIES, R. E. (1967). *J. Reprod. Fert.* 13, 237–249.
LAVON, U., VOLCANI, R., AMIR, D. & DANON, D. (1966). *J. Reprod. Fert.* 11, 447–449.
LINDAHL, P. E. & KIHLESTRÖM, J. E. (1952). *J. Dairy Sci.* 35, 393–402.

Searle's apparatus used to study the temperature dependence of amino acid transport by the goldfish intestine

By T. B. MEPHAM* and M. W. SMITH. *A.R.C. Institute of Animal Physiology, Babraham, Cambridge*

The diagram represents a modified version of Searle's apparatus used to measure the thermal conductivity of certain metals.

This simple apparatus has proved most valuable in the study of the temperature dependence of amino acid transport by goldfish intestine and the means by which this transport is regulated. Initial work established that the everted goldfish intestine could actively transport many different amino acids (Mepham & Smith, 1966*a*). Further work distinguished between the immediate (incubation temperature) and long term (acclimatization temperature) effect of temperature on the transport of certain selected amino acids (Mepham & Smith, 1966*b*; Smith, 1967). More recent work has

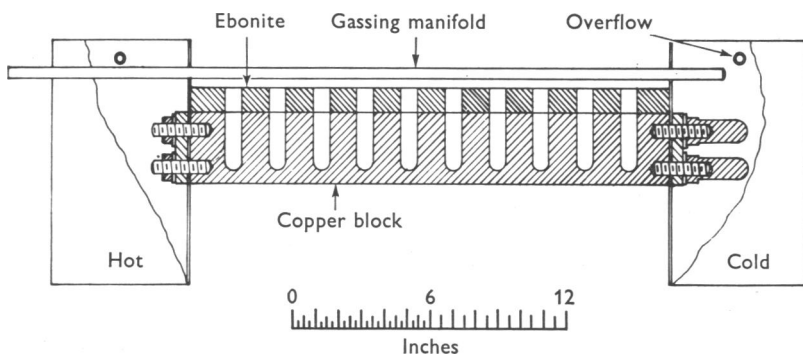

Fig. 1. An apparatus for maintaining a range of constant temperatures. Copper rods connect an ice-bath to a heated bath. The temperature of the heated bath is controlled to maintain a 7-31° C temperature gradient along the copper. Holes drilled into the copper hold tubes containing bicarbonate saline gassed with 95% O₂ + 5% CO₂. The temperatures of these solutions, monitored with a Grant thermistor thermometer ($\pm 0.05^\circ$ C), quickly reach those of the surrounding metal. The stability of the system depends on the rate at which these solutions are bubbled, on the rate of stirring in the hot and cold reservoir and on the efficiency with which the copper rods are insulated. The apparatus follows the design of Selwyn (1961).

been concerned to establish the mechanisms whereby goldfish regulate selectively the intestinal transport of different amino acids to suit a changed environmental temperature. Cycloleucine and α -aminoisobutyric acid were chosen for this study since these amino acids are said to use different mechanisms when crossing the plasma membranes of intestinal epithelial cells (Christensen, 1962).

* Present address: University of Nottingham, School of Agriculture, Sutton Bonington, Loughborough.

REFERENCES

- CHRISTENSEN, H. N. (1962). *Fedn Proc.* **21**, 37-42.
MEPHAM, T. B. & SMITH, M. W. (1966a). *J. Physiol.* **184**, 673-684.
MEPHAM, T. B. & SMITH, M. W. (1966b). *J. Physiol.* **186**, 619-631.
SELWYN, M. J. (1961). *Biochem. J.* **79**, 38.
SMITH, M. W. (1967). *Experientia* **23**, 548-549.

Birefringence changes during nerve activity

By L. B. COHEN and R. D. KEYNES. *A.R.C. Institute of Animal Physiology, Babraham, Cambridge*

Quantitative studies on the degradation of chloroplasts in the rumen

By J. L. MANGAN and M. JANE PRYOR.* *A.R.C. Institute of Animal Physiology, Babraham, Cambridge*

By analysis of food boli collected at the cardia of rumen-fistulated cattle, Reid, Lyttleton & Mangan (1962) showed that during chewing cattle released 50-60% of the leaf-cytoplasmic protein and 25-35% of the chloroplasts from herbage. Chloroplasts contain about 50% protein on dry weight, and are therefore an important source of available protein in the rumen of pasture-fed animals.

Chloroplasts were prepared from rye leaves by gentle grinding in a mechanical mortar and pestle (Pascal Engineering Co., Ltd.) with two volumes of 0.1 M-K₂HPO₄ at 4° C for 2 min. The macerate was filtered through muslin and centrifuged for 10 min at 800 g at 0° C to remove plant debris. Chloroplasts were then spun down at 1000 g for 30 min at 0° C and after removal of the supernatant were resuspended in synthetic saliva (McDougall, 1948) which had been adjusted to pH 6.5 with acetic acid. The yield was 1-2% of the wet weight and sufficient material could be obtained to dose individual sheep and cattle.

The experimental animals had permanently cannulated rumen fistulae (Harrison, 1961; Jarrett, 1948) and during the experiments the rumen fluid was continuously sampled by a peristaltic pump into a collecting device where the timed samples were held at 0° C. The animals were fed a standard ration and 3 hr later the chloroplast suspension was introduced through the rumen cannula. In order to measure rumen fluid volumes known quantities of polyethylene glycol mol. wt. 4000 (Hyden, 1955) and lithium sulphate (Mangan & Wright, 1968) were added with the chloroplast suspension.

The particulate matter of the rumen fluid samples was fractionated on

* In receipt of a Unilever Fellowship.

discontinuous sucrose density gradients (46 %, 50 %, 65 %, 75 % w/v sucrose) centrifuging for 1 hr at 0° C at 1000 *g*. Fractions, in increasing order of density, were obtained corresponding to: F 1, small bacteria; F 2, large bacteria; F 3, *Dasytricha* spp.; F 4, plant-cell debris and few dasytricha and entodinia cells; F 5, *Entodinia* spp.; F 6, few entodinia and plant debris; F 7, *Isotricha* spp. and heavy plant fibres. In the same gradient system the chloroplast preparation gave two bands corresponding to F 1 and F 2 above and composed of granular (stripped) chloroplasts and intact chloroplasts respectively.

Three sheep and two cattle experiments have shown that after the administration of chloroplasts to the rumen there was no detectable increase in soluble nitrogenous compounds in the rumen fluid, and in particular ammonia and δ -amino valeric acid, which are typical products of the degradation of soluble proteins in the rumen, were not formed. Gradient fractions were analysed for DNA, crude protein and chlorophyll. The protozoal fractions showed no increase in DNA during the experimental period. F 1 and F 2 showed increases in DNA and protein during or after feeding the test ration, indicating increases in the number of bacterial cells. After the addition of chloroplasts, chlorophyll increased in F 1 and F 2, representing free chloroplasts, and in all experiments there was a marked increase in the chlorophyll content of F 5. The chlorophyll:DNA ratio increased greatly. Microscopic examination confirmed that *Entodinia* species of protozoa had ingested considerable quantities of chloroplasts. The degradation of ingested chloroplasts, as measured by disappearance of chlorophyll, was quite rapid; in one experiment the break-down was almost complete in 3 hr. Coleman (1964, 1967) has shown that bacteria were ingested and rapidly degraded by *Entodinium caudatum in vitro*. At least 50 % of the bacterial protein amino acids were incorporated into protozoal protein without release into the medium. The absence of soluble degradation products when chloroplasts are degraded in the rumen indicates that a similar mechanism may operate.

REFERENCES

- COLEMAN, G. S. (1964). *J. gen. Microbiol.* **37**, 209.
 COLEMAN, G. S. (1967). *J. gen. Microbiol.* **47**, 449.
 HARRISON, F. A. (1961). *Vet. Rec.* **73**, 942.
 HYDEN, S. (1955). *LantbrHögsk Annlr* **22**, 139.
 JARRETT, I. G. (1948). *J. Coun. scient. ind. Res. Aust.* **21**, 311.
 McDUGALL, E. I. (1948). *Biochem. J.* **43**, 99.
 MANGAN, J. L. & WRIGHT, P. C. (1968). *Res. vet. Sci.* **9**, 366-375.
 REID, C. S. W., LYTTLETON, J. W. & MANGAN, J. L. (1962). *N.Z. Jl agric. Res.* **5**, 237-248.

Protein-lipid interactions studied using monolayers of phospholipid and radioactive cytochrome *c*

By R. M. C. DAWSON and P. J. QUINN. *A.R.C. Institute of Animal Physiology, Babraham, Cambridge*

It has been suggested that in mitochondria cytochrome *c* associates with acidic phospholipids. The nature of the interaction between such substances is being studied with monolayers of phospholipid on a subphase containing cytochrome *c* made radioactive by reacting it with ^{14}C iodoacetic acid. Continuous recordings of surface pressure, surface radioactivity and interfacial potential are made during the interaction of the protein and phospholipid film. From the surface radioactivity measurements, it is possible to distinguish between penetration of protein into the phospholipid film producing an increase in surface pressure, and adsorption on to the film which does not change this parameter. The variation of the reaction produced by different types of phospholipid film and by varying the area per molecule of phospholipid at the interface, the subphase pH and the cation concentration was examined.

The effects of some anaesthetics on model phospholipid membranes

By A. D. BANGHAM and SHEENA JOHNSON. *A.R.C. Institute of Animal Physiology, Babraham, Cambridge*

The use of operant conditioning in the study of sodium appetite in goats

By B. A. BALDWIN. *A.R.C. Institute of Animal Physiology, Babraham, Cambridge*

In sheep which had been made sodium deficient by a parotid salivary fistula, intracarotid injections of 4 M-NaCl which raised the sodium concentration in the cephalic circulation to above normal values, did not prevent them avidly drinking sodium bicarbonate solutions (Beilharz, Bott, Denton & Sabine, 1965). Miller (1967) has emphasized the advantages of using several types of behavioural tests in addition to simple consummatory responses and operant conditioning has proved particularly useful in the study of ingestive behaviour.

Goats made sodium deficient with a parotid fistula have made good subjects for operant conditioning. The goat, loosely restrained on a raised stand by means of a neck yoke, faced a black Perspex panel into which was inset a small transparent panel which was illuminated when the apparatus was turned on. Slight pressure on the illuminated panel operated a micro-switch connected to programming apparatus which dispensed 5 ml.

volumes of 4.2% NaHCO₃ solution. All presses on the panel (responses) and all deliveries of bicarbonate (reinforcements) were recorded on counters and a written record on a cumulative recorder displayed changes in the rate of responding. The goat stand was enclosed in a sound shielded chamber.

With initial assistance from the experimenter, using a hand switch to deliver reinforcements when the goat placed its muzzle near the illuminated panel, depleted goats soon learned to operate the panel switch. Trained goats will press the panel 10 or more times to obtain one reinforcement and provided the trials only last about 20 min each day the goats do not repair their sodium deficit and may be tested daily. If depleted goats are given salt licks in their pens and 1% NaHCO₃ solution *ad libitum* instead of drinking water the salivary Na⁺/K⁺ ratio becomes 25 or more instead of about 0.5 or less in the depleted state and trained goats no longer respond to obtain 4.2% NaHCO₃.

Results from three goats with bilateral carotid loops show that unilateral intracarotid injections of 4 M-NaCl at 3.84 ml./min with the opposite loop occluded did not prevent trained goats starting to respond when the panel was switched on. The injections started 5 min before the panel was turned on and continued for a further 8-10 min. The unilateral carotid occlusion ensured a bilateral distribution of the injected NaCl (Baldwin & Bell, 1963) and blood samples taken from the ipsilateral jugular vein during the injection revealed a rise in plasma sodium of 11-18 m-equiv/l. above normal values. Similar injections commencing after the goat had begun responding had no effect on the response rate.

The results confirm the findings in sheep (Beilharz *et al.* 1965) and show that the technique of intracarotid injection during the performance of operant responses which has previously been used to study the effects of drugs and electrolytes (Baldwin, Wenzel & Tschirgi, 1967) may be useful in the investigation of sodium appetite.

REFERENCES

- BALDWIN, B. A. & BELL, F. R. (1963). *J. Anat.* **97**, 203-215.
 BALDWIN, B. A., WENZEL, B. M. & TSCHIRGI, R. D. (1967). *Physiol. Behav.* **2**, 23-31.
 BEILHARZ, S., BOTT, E. A., DENTON, D. A. & SABINE, J. R. (1965). *J. Physiol.* **178**, 80-91.
 MILLER, N. E. (1967). In *Handbook of Physiology*, section 6: Alimentary Canal, vol. 1, pp. 51-61. Washington, D.C.: American Physiological Society.

A microscope warm stage

By D. V. BARKER, B. GREENWOOD and C. C. INGREY. *A.R.C. Institute of Animal Physiology, Babraham, Cambridge*

This stage is a development of one made of Perspex and devised by the Engineering Division of the National Institute for Medical Research, Mill

Hill. A similar one made by C and D Scientific Instruments Limited used to be commercially obtainable. It takes the form of a shallow heated box, through the lid of which the microscope objective is lowered. The base of the box is cut away to permit the specimen to rest on the microscope stage, allowing a normal working length condenser to be used with phase contrast optics.

In the stage modified here, the casing is machined in one piece from aluminium alloy, which facilitates heating of the microscope stage itself, and the passage of heat to the underside of the preparation. The specimen is thus practically surrounded by a constant heat supply. Increased heat loss is compensated for by the two more powerful heating coils made from 25 s.w.g. Nichrome wire consuming 1.2 amps at 6 volts, and mounted in 3/16 in. bore Pyrex glass tube. The sprung contact thermostat inside the box has been further exposed to one heating coil, and made more reliable by fitting platinum contacts.

The metal base of the box is deep enough to obstruct the passage of microscope objectives towards the heating coils and so prevent their exposure to intense direct heat.

In order to accommodate modified Mackness tissue culture chambers and the smaller standard microscope slides, the base aperture, which itself carries a spring clip, can be reduced by inserting a sprung steel frame.

A refined version of this stage has a primary thermostat control placed at a distance and driven by a thermistor in the box. A second, small, sprung contact thermostat in the box serves as a safety device so that failure of the primary thermostat will lead to cut out at a slightly higher temperature. The purpose of this is protection, not only of cultures, but of the objective, which is often left in the box for long periods during filming.

The warm stage can be variously adapted to fix to mechanical microscope stages, and has been used with equal success on both conventional and inverted microscopes. In the latter case, a phase contrast condenser replaces the objective projecting through the lid.

A simple method for ensuring blood leucocyte motility on glass

By B. GREENWOOD. *A.R.C. Institute of Animal Physiology, Babraham, Cambridge*

In the study of blood eosinophil motility it has been observed (Greenwood, 1968) that these cells are often disinclined to begin movement on glass, but, once active, they move much more swiftly than has often been assumed.

Speirs (1962), using mouse eosinophils, coated glass with formalin-

treated gelatin or cross-linked thiogel, and Archer & Hirsch (1963), with horse eosinophils, used formvar-coated glass slides to obtain motility. The latter authors also adsorbed the suspending serum with powdered borosilicate glass. Formvar produces marked spreading of human and sheep granulocytes, a phenomenon which displays cell detail but leads to little movement.

McCutcheon (1924), studying lymphocyte motility, commented on an increase in both the number of active cells and the rate of movement, with increased time in hours under the microscope.

A trivial method has presented itself for providing marked activity in the different groups of sheep and human leucocytes.

Heparinized venous blood is taken into a sterile syringe, a large air bubble drawn in, and the syringe capped and incubated at body temperature for a few hours. White cells are then separated by centrifugation in a micro-haematocrit tube, and suspended in their own plasma on a clean slide under a cover-slip. When viewed on the microscope warm stage motility is usually soon apparent.

Two details should be stressed, although perhaps obvious: (1) the introduction of an air bubble into the syringe is essential: without it the leucocytes rapidly die. (2) The leucocytes must be fairly quickly transferred from the micro-haematocrit tube to a slide after centrifugation and cell packing, although cell death can be deferred by storing the tube at 4° C.

When examined on the warm stage, under phase-contrast, each group of human cells shows motility. Some cell vacuolation is apparent if incubation has lasted 24 hr. Vacuolation is usually trivial in sheep leucocytes after 24 hr incubation, and good motility has been observed in sheep blood left without incubation, but with an air bubble, for 3 days. After 4 days, without incubation, only eosinophils and monocytes were active.

These findings may be compared with those of Crosbie & Scarborough (1940) studying leucocytes in citrated human blood stored at 2-5° C. Examining blood films at 35° C they found that motility was marked in most preparations during the first 4 days of storage, but could be observed in all bloods for 8 days, and, in one, for 16 days.

In the sheep and human bloods used here, no differences in movement between fresh and incubated cells have been apparent.

REFERENCES

- ARCHER, G. T. & HIRSCH, J. G. (1963). *J. exp. Med.* **118**, 287-294.
 CROSBIE, A. & SCARBOROUGH, H. (1940). *Edinb. med. J.* **47**, 553-566.
 GREENWOOD, B. (1968). *J. Physiol.* **196**, 108-109 P.
 MCCUTCHEON, M. (1924). *Am. J. Physiol.* **69**, 279-282.
 SPEIRS, R. S. (1962). *Blood* **20**, 108.

Brown fat as one of the notable sites of growth [?metastasis] of a reticulo-endothelial tumour in an inbred strain of rats, following subcutaneous transplantation

By A. MARION TOMKYS. *A.R.C. Institute of Animal Physiology, Babraham, Cambridge*

Antibody activity and structure

By D. BEALE, M. J. HOBART and E. A. MUNN. *A.R.C. Institute of Animal Physiology, Babraham, Cambridge*

Micropuncture of nephrons of new-born pig

By MARGARET W. STANIER. *A.R.C. Institute of Animal Physiology, Babraham, Cambridge*

When the urine of the mammal becomes more dilute than the plasma, the process of dilution occurs by reabsorption of sodium without the isosmotic amount of water in the ascending limb of Henle's loop and possibly in the distal convoluted tubule also. The urine of the foetal pig is in fact markedly hypotonic to the plasma (McCance & Stanier, 1960). In the new-born animal also, the nephron reabsorbs sodium vigorously (McCance & Widdowson, 1957). The question arises, whether in foetal and young animals the proximal tubule participates in the diluting mechanism by reabsorbing sodium without the corresponding amount of water. Proximal sodium reabsorption is also of interest because an effect of growth hormone on it has been postulated (Lockett & Roberts, 1963). Analysis of samples of fluids from specified regions of the convoluted tubules of new-born and foetal pigs would provide answers to these questions. To obtain such samples a technique of nephron micropuncture has been developed.

The left kidney of an anaesthetized new-born pig is exposed by incision of the body wall and cutting of the two lower ribs close to the vertebrae. The left ureter is cannulated, the connective tissue around the kidney is cut away, and the kidney is gently lifted and placed in a Perspex kidney box. The kidney box has an open top and a hole in the base to accommodate the renal vessels and ureter. The box is made in two halves fastened together by clips. The two halves are inserted separately around the rostral and caudal ends of the kidney and clipped together. One end of the box is fixed by small screws into a brass cup mounted on a brass rod clamped to a heavy base, and the kidney is thus kept still enough for insertion of micropipettes. Warm liquid paraffin is poured over the kidney to keep its surface warm and to prevent evaporation. The liquid paraffin slowly leaks away through the base of the box and is replaced from a reservoir through tubing surrounded by a hot-water jacket.

A Pyrex glass micropipette (tip diameter 7-12 μ), previously filled with liquid paraffin stained with Sudan Black, is screwed into a small brass chuck. The shank of the micropipette is fastened to plastic tubing emerging from the end of a brass tube mounted in a micromanipulator. The chuck is inserted into the brass tube by a tight push-fit. The other end of the plastic tubing is joined to a 17G luer-lock needle and syringe. The surface of the kidney is viewed through a dissecting microscope at magnitude $\times 50$ or $\times 100$. The outer layer of capsule is stripped off and the coils of nephron are clearly visible. The micropipette is advanced and inserted, and a small amount of the stained liquid paraffin is injected by pressure on the syringe. If the tip of the micropipette is in the nephron, the outline of the surface coils of this nephron will show up dark, as they fill with stained paraffin. Sometimes it is necessary to remove a portion of the capsule before inserting the micropipette; but it is normally possible to make the insertion through the lowest layer of the capsule. The insertion is made easier by establishing a brisk diuresis by means of a mannitol-saline infusion into the pig's jugular vein.

The procedure for exposing and immobilizing the kidney surface and inserting the micropipette was demonstrated.

REFERENCES

- LOCKETT, M. A. & ROBERTS, C. N. (1963). *J. Physiol.* **165**, 69 P.
MCCANCE, R. A. & STANIER, M. W. (1960). *J. Physiol.* **151**, 479-485.
MCCANCE, R. A. & WIDDOWSON, E. M. (1957). *Acta paediat., Stockh.* **46**, 337-353.

Liver transplantation in the pig

By R. M. BINNS, R. Y. CALNE, D. R. DAVIS, R. N. HERBERTSON, R. R. MAGINN, P. R. MILLARD, V. P. MOLINA, J. R. PENA, J. R. SALAMAN, J. R. SAMUEL, H. J. O. WHITE, D. E. YOFFA and M. ZAKIECICZ. *A.R.C. Institute of Animal Physiology, Babraham, Cambridge*

An operating table for large and small animals

By F. A. HARRISON. *A.R.C. Institute of Animal Physiology, Babraham, Cambridge*

Improved techniques for the chronic cannulation of the lateral cerebral ventricle and the cisterna magna of the Welsh Mountain sheep

By A. J. BARTON, J. BLIGH and D. F. SHARMAN. *A.R.C. Institute of Animal Physiology, Babraham, Cambridge*

Techniques already exist for the chronic cannulation of the lateral cerebral ventricles (Palmer, 1959) and the cisterna magna (Wykoff &

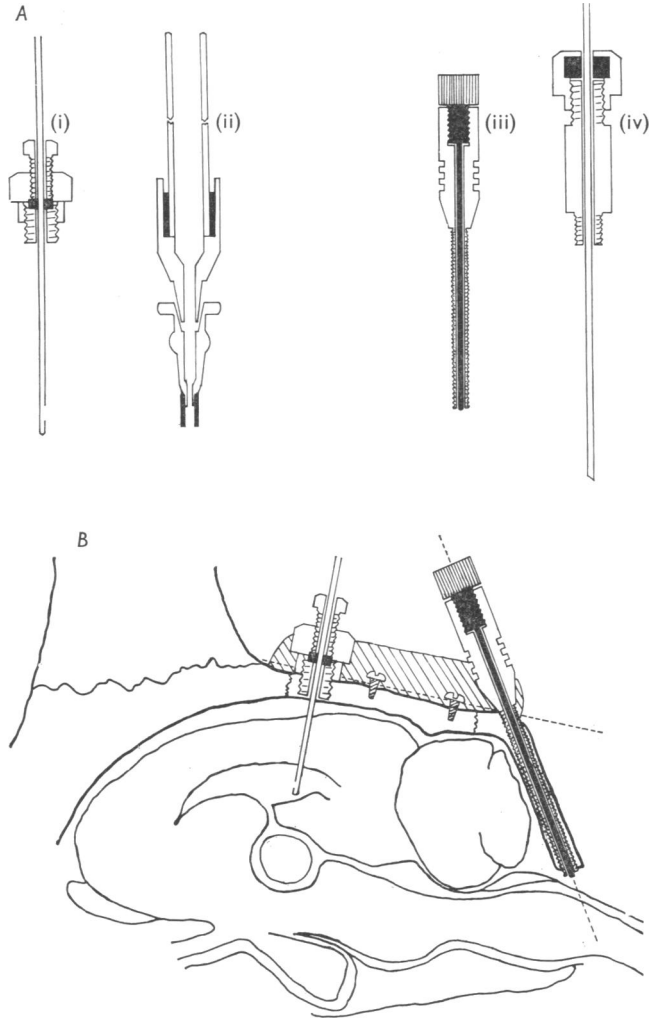

Fig. 1A. (i) Lateral ventricle cannula assembly. The compression of the washer (solid black) by the nut above it clamps the cannula into position. (ii) The column of fluid which is attached to the top of the cannula while it is being pushed through the guide-tube and locking nut into the lateral ventricle. (iii) The externally threaded guide tube and stilette which is inserted into the occipital bone. (iv) The needle for penetration into the cisterna magna. This also is locked into position by compression of a rubber washer.

B. The lateral ventricle cannula and cisterna magna guide-tube in position in the skull. The assembly is held rigid by the acrylic cement (hatched) and the two anchoring screws. The dotted lines indicate the angle of the drill determined by previous X-ray photography.

Short, 1960) of sheep, but in our experience each technique has disadvantages and we have therefore sought for ways in which to improve them.

To overcome the need to pre-determine the depth of insertion of the lateral ventricle cannula when a fixed assembly is finally screwed into the skull, we have re-designed the assembly so that no further lowering of the cannula is necessary once the movement of fluid in the column above it indicates that the ventricle has been entered. This is achieved by first screwing a guide-sleeve into the skull. The cannula is inserted through it and locked in position at the correct depth by compressing a rubber washer so that it tightens round the cannula shaft (Fig. 1A, B).

For chronic cannulation of the cisterna magna, the assembly must be well anchored in skull bone and excessive damage to the dorsal neck muscles and to their occipital attachment must be avoided. These disadvantages which are inherent in the technique of Wykoff & Short (1960) have been overcome by employing an approach similar to that used in goats by Pappenheimer, Heisey, Jordan & Downer (1962). The skull is exposed in the region of the nuchal crest of the occipital bone through a mid line incision. At a mid-line point just rostral to this crest a shaft is drilled through the occipital bone at an angle determined by previous X-ray photography of the head (Fig. 1B). Drilling is stopped as soon as it can be felt that the drill tip has emerged from the bone above the cisterna magna. A threaded guide-tube containing a stilette is screwed down into the shaft until, by calculation from the previous drill depth, the stilette slightly protrudes into the caudal orifice of the skull through which the cord passes (Fig. 1A, B).

Post-operatively, the stilette can be removed and a sharp hypodermic needle introduced down the guide tube, through the dura and into the cisterna magna. The needle is locked into position (Fig. 1A).

Horned Welsh Mountain sheep are used because the horns offer protection for the parts of the cannulae which are external to the skin. Both cannulae can be introduced through one large mid line incision. Stainless-steel anchoring screws and acrylic dental cement are used to strengthen the anchorage of the cannulae to the skull bones. The open outer end of the lateral ventricular cannula is sealed with a blind-ended polyethylene sleeve. The cannula is flushed through with a small quantity of saline each 2-3 days to keep the ventricular orifice free of obstruction.

REFERENCES

- PALMER, A. C. (1959). *J. Physiol.* **149**, 209-214.
 PAPPENHEIMER, J. R., HEISEY, S. R., JORDAN, E. F. & DOWNER, J. DE C. (1962). *Am. J. Physiol.* **203**, 763-774.
 WYKOFF, M. H. & SHORT, C. E. (1960) *Am. J. vet. Res.* **27**, 819-821.

The introduction and maintenance of permanently indwelling catheters in the portal and hepatic veins of the sheep

By F. A. HARRISON, *A.R.C. Institute of Animal Physiology, Babraham, Cambridge*

For the purpose of certain observations on liver function in the conscious sheep, ways of introducing and maintaining permanently indwelling catheters in the portal and hepatic veins were required. For portal vein catheters we have used the technique devised by K. J. Hill in this Institute (see Lewis, Hill & Annison, 1957), in which the catheter is introduced into a mesenteric venous tributary and passed along the vein until the tip is found by digital palpation to be located at the porta hepatis.

For sampling hepatic venous blood in the sheep, Aliev (1966) introduced a catheter into one of the hepatic veins near to its junction with the posterior vena cava. As the catheters in the portal vein lie with and not against the flow of blood, it was decided to try to establish hepatic vein catheters lying with the flow of blood. The catheters used for portal and hepatic sampling were 90 cm lengths of surgical non-toxic grade transparent vinyl tube (Portex No. NT 3-SH 95; Portland Plastics Ltd., Hythe, Kent). These were sterilized overnight in 0.5% chlorhexidine ('Hibitane' concentrate 5%; ICI Ltd., Macclesfield, Cheshire) in 70% alcohol and flushed with sterile saline at operation.

At a preliminary operation, a carotid artery was exteriorized in a skin loop and the rumen fistulated. The sheep were normally housed indoors and fed 1000 g chaffed hay and 200 g crushed oats once daily with water *ad libitum* and free access to a mineralized salt lick. Food was withheld for 36 hr before the vessels were catheterized; this allowed easy emptying of the rumen contents which were stored in an incubator at 39° C during the operation. Anaesthesia was induced with intravenous sodium pentobarbitone and, after endotracheal intubation with a cuffed Magill tube, was maintained with either cyclopropane or halothane ('Fluothane', ICI Ltd., Macclesfield, Cheshire) and oxygen in a closed-circuit rebreathing system.

The animal was placed on its left side on the operating table which was tilted downwards and backwards; the animal's head was allowed to slope downwards and forwards. The right flank was clipped and washed with soap and water and finally rinsed with 70% alcohol. Aseptic techniques were used for the operations. A right para-costal incision about 20 cm long was made to allow exposure of the diaphragmatic surface of the liver and the posterior vena cava at the level of the foramen dextrum of the diaphragm. A flexible stainless-wire stilette (45 cm long and approx. 1.2 mm thick) was inserted through a needle puncture in the vena cava at

the foramen dextrum (Fig. 1, lower part), manipulated into one of the two main hepatic veins and thence passed along the vein until it emerged through the edge of the corresponding lobe of the liver. The catheter was then passed over the exposed tip of the stilette and into the hepatic vein so that the opening was 10-12 cm from the edge of the liver where the

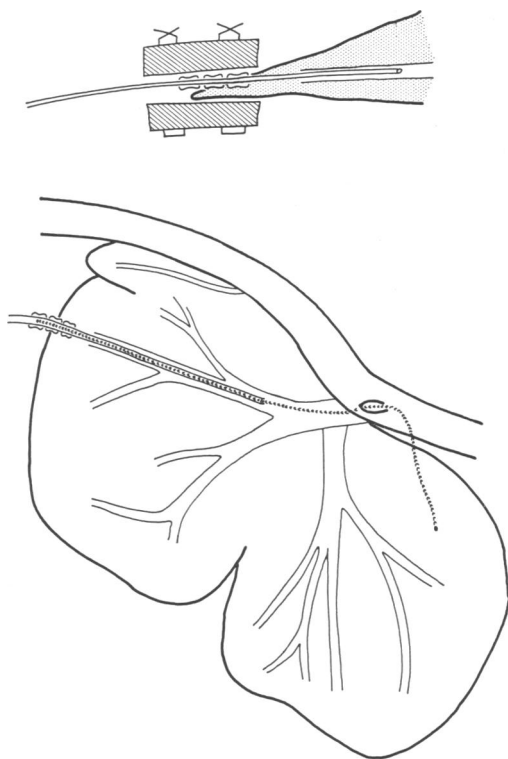

Fig. 1. Upper part. Diagrammatic section through the liver to show the use of surgical sponge and polythene collars for anchoring the catheter in the hepatic vein. Lower part. Diagram of the diaphragmatic surface of the liver with outline of the main hepatic veins. This was obtained from an X-ray picture of the liver after retrograde injection of a radio-opaque suspension ('Chromopaque', Damancy and Co. Ltd., Ware, Herts.) into the hepatic venous system. The stilette is shown entering the needle puncture of the vena cava and lying in the hepatic vein with the catheter passed over the tip emerging through the edge of the liver.

catheter was fixed with the aid of several close-fitting collars of polythene tube. Pieces of polyvinyl surgical sponge ('Ivalon', Clay-Adams Inc., New York) were laid across the edge of the liver and two or three mattress sutures (2/0 chromic catgut mersuture) were inserted to fix the sponge to the liver and to anchor the catheter at the collars (Fig. 1, upper part). The free-end of the catheter was attached by a needle to a syringe filled with heparin-

saline (50 i.u./ml.); on removal of the stilette, the patency of the catheter was checked by withdrawal of blood and flushing with heparin-saline. The vena cava was sutured when necessary (using 4/0 braided silk mersuture) and the operating table was tilted forwards.

The portal vein catheter was introduced between ligatures (2/0 non-capillary braided silk) around a small mesenteric vein and passed up to lie at the porta hepatis. The free-end of this catheter was brought through a small stab at a suitable place in the greater omentum. Both catheters were brought to the exterior by passing the free-ends through the lumen of a long needle (30 cm) inserted through the abdominal muscles and passed subcutaneously to the required position over the lumbar muscles; about 20 cm of each catheter was allowed to lie free in the abdominal cavity.

After flushing each catheter with heparin-saline (50 i.u./ml.), the ends were closed with short stainless-wire plugs. Post-operatively, the patency of the catheters was checked once daily by gentle aspiration of the contents of each catheter until blood was seen. Each catheter was then flushed with 5 ml. heparin-saline (500 i.u./ml.). For this daily routine, sterile solutions, syringes and catheter-needles were used and the catheter tips and wire plugs swabbed with 70% alcohol when disconnected.

Six out of nine portal/hepatic catheterizations were successful. The last four animals were between 111 and 118 days pregnant at operation and, after successful catheterizations, they lambed normally after 142 to 147 days of gestation (three single lambs and one pair of twins). The catheters in three of these animals remained patent 70–84 days and in the other animal are still patent 140 days after operation.

REFERENCES

- ALIEV, A. A. (1966). *Fiziol. Zh. SSSR*, **52**, 1156–1160.
LEWIS, D., HILL, K. J. & ANNISON, E. F. (1957). *Biochem. J.* **66**, 587–592.

The hepatic uptake of cortisol in sheep

By F. A. HARRISON and J. Y. F. PATERSON. *A.R.C. Institute of Animal Physiology, Babraham, Cambridge*

Hepatic plasma flow (EHPF) was estimated in both anaesthetized and conscious sheep with indwelling catheters in the portal and one hepatic vein, by measuring the uptake of sulphobromophthalein (BSP) during continuous infusion. EHPF was 418 ± 115 (S.E.M., $n = 5$) ml. min⁻¹ in anaesthetized sheep and 1371 ± 181 (S.E.M., $n = 10$) ml. min⁻¹ in conscious animals.

Tritium-labelled cortisol in trace amounts was given by i.v. infusion at constant rate and its concentration in jugular (abdominal aorta in anaesthetized animals), portal and hepatic venous plasmas measured. The

uptake of labelled cortisol from the abdominal aorta (or jugular vein) to the hepatic vein was 56 ± 5 (S.E.M., $n = 13$) % of its rate of infusion. The binding of cortisol by plasma proteins was determined. There was a significant correlation between the uptake of cortisol and the rate of entry of unbound cortisol into the region ($r = 0.966$, $t = 11.848$, 11 degrees freedom). The rate of uptake was 1.54 times the rate of entry of unbound cortisol, so there was dissociation of protein-bound cortisol. The concentration of total cortisol in hepatic venous plasma was closely correlated with the concentration of transcortin-bound cortisol measured in jugular venous plasma ($r = 0.773$, $t = 4.038$, 11 degrees freedom). This suggests that the dissociation of cortisol from protein may involve albumin-bound, rather than transcortin-bound, cortisol.

Occlusion of the autotransplanted adrenal gland in the sheep and its effect on renal excretion of potassium

By F. A. HARRISON, R. D. KEYNES and JENNIFER L. PEARSON. *A.R.C. Institute of Animal Physiology, Babraham, Cambridge*

The use of right adrenalectomized sheep with autotransplanted left adrenal glands (McDonald, Goding & Wright, 1958) in investigations of renal excretion of potassium offers the possibility of functional adrenalectomy in the conscious animal, and provides an opportunity to study the control of potassium excretion without the influence of adrenal steroid hormones. Preliminary observations (Keynes & Harrison, 1967) showed that occlusion of the blood supply to the autotransplanted gland was a suitable method of functional adrenalectomy and we have now made repeated occlusions for periods up to 8 hr in each of six animals with no subsequent clinical evidence of damage to their transplanted adrenals. The technique used involved occlusion of the carotid artery and jugular vein on each side of the anastomosed adrenal by pressure cuffs around the skin loop containing these structures. At intervals of 30-40 min, the pressure in each cuff was released to 100 mm Hg for 30 sec and a small amount of arterial blood allowed to circulate through the gland with drainage from a catheter in the adrenojugular vein. To avoid clotting in the drainage catheter, small doses of heparin (5000-10,000 i.u.) were given intravenously to the animal every 2-3 hr during occlusion experiments.

For experimental observations the sheep were placed in metabolism cages and maintained as previously demonstrated to the Society (Dewhurst & Harrison, 1966) and later described (Dewhurst, Harrison & Keynes, 1968). Hourly collections of urine were made by continuous drainage from the urinary bladder with an indwelling Foley catheter. Catheterization was performed under epidural procaine anaesthesia in the afternoon of the

day before experiment. When required, the appropriate blood vessel catheters were introduced under local anaesthesia between 9 and 10 a.m. on the day of experiment. The sheep were then given the daily ration of food and hourly collection of urine was commenced.

Because of individual variations between animals and at different times in the same animal, hourly urinary excretion data were related to the sample before occlusion, which was represented as unity, and other data as

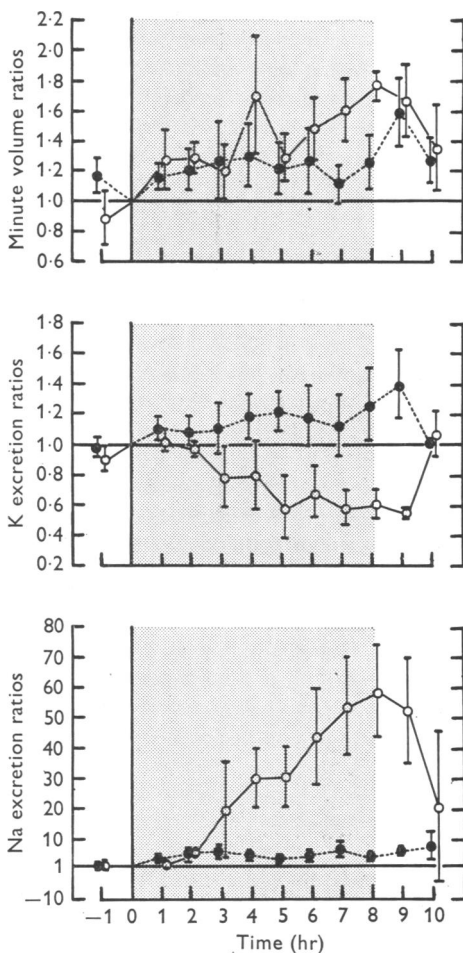

Fig. 1. Mean data for minute volume, K and Na excretion in 7 control experiments on four sheep (●---●) and 4 experiments with occlusion of the adrenal for 8 hr (shaded area) in four sheep (○---○). Vertical bars represent $2 \times$ s.e.m. The ratios are calculated with respect to time 0 = 1. Mean values at time 0 were: control experiments, minute volume 0.67 ml./min; K excretion 273 μ -equiv/min; Na excretion 8.8 μ -equiv/min. Occlusion experiments, minute volume 0.43 ml./min; K excretion 170 μ -equiv/min; Na excretion 15.5 μ -equiv/min.

the appropriate fraction or multiple. Since the adrenal was usually first occluded at about 12.30 p.m., the data for the period 11.30 a.m. to 12.30 p.m. in control experiments were represented as unity. Figure 1 summarizes the mean data for minute volume, potassium and sodium excretion obtained in a series of control experiments and a series of 8 hr adrenal occlusion experiments. Occlusion of the adrenal did not appear to disturb the sheep which continued to eat and ruminate as in control experiments.

Between 2 and 4 hr after the start of occlusion there was a fall in K excretion to less than 70% of the level before occlusion, and recovery did not occur until the second hour after releasing the occlusion. A simultaneous increase in sodium excretion occurred and in the last 2 hr of occlusion the increment in Na loss was 4.0 ± 1.9 (S.E.M., $n = 4$) and 3.8 ± 0.8 (S.E.M., $n = 4$) times greater than the decrement in K excretion.

When an intravenous infusion of KCl was given (176 mM KCl at 1 ml./min for 2 hr) during occlusion of the adrenal there was a further increase in sodium excretion whilst the excretion of potassium remained at an abnormally low level. Intravenous infusion of aldosterone (1 μ g 'Aldocorten' (CIBA)/ml. H₂O, at 0.19 ml./min) during adrenal occlusion reduced the rate of sodium excretion and caused an increase in potassium excretion from less than 50% of the level before occlusion to about 80% of this level.

Adrenal occlusion with simultaneous infusion of hydrocortisone (160 μ g hydrocortisone (BDH)/ml. saline at 0.19 ml./min) did not reduce the excessive sodium loss and showed no significant effect on K excretion.

REFERENCES

- DEWHURST, J. K. & HARRISON, F. A. (1966). *J. Physiol.* **186**, 78-79 P.
 DEWHURST, J. K., HARRISON, F. A. & KEYNES, R. D. (1968). *J. Physiol.* **195**, 609-621.
 KEYNES, R. D. & HARRISON, F. A. (1967). *Vet. Rec.* **81**, 244-250.
 McDONALD, I. R., GODING, J. R. & WRIGHT, R. D. (1958). *Aust. J. exp. Biol. med. Sci.* **36**, 83-96.

Steroids in adrenal venous blood of rats

By MARGARETHE HOLZBAUER. *A.R.C. Institute of Animal Physiology, Babraham, Cambridge*

Gas chromatographic evidence for the presence of glycol metabolites of catecholamines in brain tissue

By D. F. SHARMAN. *A.R.C. Institute of Animal Physiology, Babraham, Cambridge*

It has been shown by Rutledge & Jonason (1967) that rabbit brain slices can metabolize noradrenaline *in vitro* to 3,4-dihydroxyphenyl-

ethyleneglycol (DOPEG) and 4-hydroxy-3-methoxyphenylethyleneglycol (MOPEG). Schanberg, Schildkraut, Breese & Kopin (1968) have reported that the ethereal sulphate conjugate of MOPEG was present in normal rat brain but were unable to detect the free compound.

DOPEG and MOPEG can be converted to heptafluorobutyric esters which can be separated by gas chromatography and measured by the electron capture detector. It was found that acetylation of the phenolic

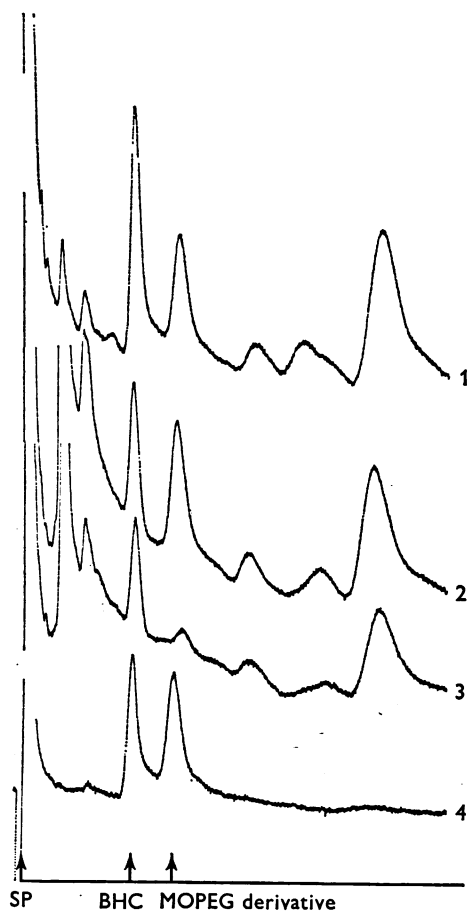

Fig. 1. Gas chromatogram record of: 1. Extract of rabbit hypothalamus. 2. Extract of rabbit cerebral cortex to which authentic 4-hydroxy-3-methoxyphenylethyleneglycol (MOPEG) had been added. 3. Extract of rabbit cerebral cortex. 4. Authentic MOPEG derivative. SP, solvent peak. BHC, Benzene hexachloride used as a reference compound. The gas chromatogram was developed on a 180 cm column of 3.8 % s.e. 30 on silanized Diatoport S (60-80 mesh). Column temperature 135° C; detector temperature 180° C; pulse interval 50 μ sec; carrier gas argon: 5 % methane; gas flow 30 ml./min at 1.7 kg/cm².

hydroxyl groups, before the esterification of the alcoholic hydroxy groups with heptafluorobutyric anhydride, yielded compounds with MOPEG and DOPEG which were more easily separated from the solvent peak of the gas chromatogram and which can be easily crystallized to form reference standards. Chromatograms developed with extracts prepared from rabbit and mouse hypothalamus have shown peaks with the same relative retention time as the compounds derived from authentic MOPEG and DOPEG. Figure 1 illustrates the evidence for the presence of very small amounts of free MOPEG in an extract of the hypothalamus of the rabbit.

The general procedure is applicable to the estimation of those catecholamines and their metabolites which contain primary or secondary alcoholic hydroxyl groups.

REFERENCES

- RUTLEDGE, C. O. & JONASON, J. (1967). *J. Pharmac. exp. Ther.* **157**, 493-502.
SCHANBERG, S. M., SCHILDKRAUT, J. J., BREESE, G. R. & KOPIN, I. J. (1968). *Biochem. Pharmac.* **17**, 247-254.

Exploratory behaviour in mice

By ELIZABETH E. SHILLITO. *A.R.C. Institute of Animal Physiology, Babraham, Cambridge*

The exploratory behaviour of mice was observed when they were placed one at a time, on a wooden board measuring 2 ft. square. Twelve plastic tunnels 3 in. long and 1½ in. diameter were fixed to the board arranged in a symmetrical pattern and each tunnel was numbered. Each mouse was watched for 5 min under red light on 2 consecutive days. The number of each tunnel entered was recorded for each minute of the observation period; from this the total number of tunnels entered was calculated and also the number of different tunnels entered. The progress of exploration through the 5 min was also noted as was the frequency with which different tunnels were entered. The drugs investigated were given by I.P. injection 30 min before observations started. One control group was always used and on the second day of the experiment no drug was given.

The behaviour of an untreated mouse on the tunnel board differed on the second day of the experiment from that of the first day. These behavioural characteristics were taken as an indication that learning had taken place on the first day, that is, exploration had been normal. More tunnels were entered on the second day and also more different tunnels were entered. The progress of exploration was changed so that more different tunnels were entered in the first 2 min of the second day than on the first day. If exploration on the first day had been affected by the drug used, the

behaviour of the treated mice on the second day did not show these characteristics.

The value of these measurements lies in their independence from the effect of drugs on general activity. Thus drugs such as chlordiazepoxide and amphetamine, given in doses which increase locomotion, did not necessarily increase exploration. Mice given these two drugs moved rapidly round the edge of the board entering the peripheral tunnels only. On the second day, they behaved as if the tunnel board was a new area to them. Mice treated with sedatives, such as chlorpromazine, thioridazine and haloperidol, moved more slowly through the area and generally into the middle of the board. A relatively high level of sedation was necessary to affect exploration sufficiently to make the mice behave as if the tunnel board was unfamiliar on a second encounter.

The effects of tranquillizers on the dopamine metabolism of the brain

By RUTH O'KEEFFE. *A.R.C. Institute of Animal Physiology, Babraham, Cambridge*

Native and cross-linked collagen fibrils and ionizing radiation with electrons

By R. W. COX AND R. A. GRANT. *A.R.C. Institute of Animal Physiology, Babraham, Cambridge*

The use of high resolution electron microscopy and negative staining techniques reveals that native collagen fibrils that have been irradiated with high energy electrons up to doses of 100 Mrads undergo irregular swelling, a progressive loss of contrast in the bands and finally disintegration. Collagen irradiated in the dry state is more prone to damage than collagen irradiated in the wet state. Similar findings up to 40 Mrads have been reported by Bailey & Tromans (1964). Chemical cross-linking of the collagen with glutaraldehyde, however, produces fibrils that are considerably more resistant to the effects of irradiation. Again, the damage is less if the irradiation occurs in the wet rather than in the dry state.

The effects of collagenase and elastase on collagen are also modified by irradiation. Native collagen irradiated in the wet state, but not in the dry state, becomes more resistant to collagenase. Collagen that has been cross-linked with glutaraldehyde and that is normally insensitive to collagenase is made sensitive to the enzyme by irradiation, although digestion is slow. Irradiation of native collagen in the dry and wet states induces a sensitivity to elastase that is normally absent. Glutaraldehyde cross-linked collagen

that has been irradiated in the dry state becomes more sensitive to elastase as the dosage of electrons increases. Irradiation in the wet state, however, renders cross-linked collagen sensitive to elastase at doses of 25 and 50 Mrads but insensitive at 100 Mrads.

Irradiation in the wet and dry states increases the solubility of native collagen in 0.5 % acetic acid. Cross-linking the collagen with glutaraldehyde before irradiation makes it insoluble in acetic acid. The solubility of native collagen in 0.1 N sodium hydroxide at 95° C is decreased by irradiation in the wet state. Cross-linking of the collagen with glutaraldehyde before irradiation in either the wet or dry state markedly lengthens the time for complete solution.

Amino acid analyses of specimens of native and glutaraldehyde cross-linked collagen that have been irradiated in the wet and dry states at 100 Mrads show no very marked differences from non-irradiated controls.

The results of these experiments are consistent with the view that irradiation with electrons of collagen in the dry state causes scission of the polypeptide chains and that in the presence of water this is accompanied by intermolecular bonding. Changes in the configuration of the polypeptide chains would also appear to accompany both processes.

REFERENCE

BAILEY, A. J. & TROMANS, W. J. (1964). *Radiat. Res.* **23**, 145-155.

Chromosome and blood-group studies of sheep twin chimaeras

By ANNE R. DAIN and ELIZABETH M. TUCKER. *A.R.C. Institute of Animal Physiology, Babraham, Cambridge*

Chimaerism results from anastomosis of blood vessels between twins during foetal life. This allows an exchange of blood cell precursors so that both lines become established in each twin. Such twins then have two populations of blood cells which are antigenically distinct, and which persist in adult life (Tucker, 1965). If the twins are of unlike sex the female member is sterile. This is the familiar freemartin condition in cattle; in sheep the condition is found but it is very rare (Fraser-Roberts & Greenwood, 1928; Ewen & Hummason, 1947; Stormont, Weir & Lane, 1953).

The blood of sheep twins was examined for the presence of mosaicism using cytological, serological and electrophoretic methods. Five pairs of twins and one female sheep whose male twin was dead were found to be chimaeras. Admixture of red cell antigens and haemoglobin types was detected and in addition, in the four pairs of twins of unlike sex, chromosome mosaicism was found. The female members of such pairs were 'freemartins'.

REFERENCES

- EWEN, A. H. & HUMMASON, F. A. (1947). *J. Hered.* **38**, 149.
 FRASER-ROBERTS, J. A. & GREENWOOD, A. W. (1928). *J. Anat.* **63**, 87.
 STORMONT, C., WEIR, W. C. & LANE, I. L. (1953). *Science, N.Y.* **118**, 695.
 TUCKER, E. M. (1965). *Proc. 9th Europ. Anim. Blood Group Conf., Prague*, p. 415. Prague: Czechoslovak Academy of Sciences.

Quantitative measurement of progesterone metabolism in the mammary gland of the goat

By R. B. HEAP, J. L. LINZELL and CECELIA A. SLOTIN.* *A.R.C. Institute of Animal Physiology, Babraham, Cambridge*

We have previously reported the mammary uptake of endogenous progesterone in goats as calculated from arteriovenous differences and mammary blood flow (Heap & Linzell, 1966). This finding has now been confirmed by the infusion of labelled progesterone, and active metabolism of the steroid by mammary tissue has been observed.

The results of two types of experiments will be demonstrated in which [7α - ^3H]- or [4 - ^{14}C]-progesterone was infused at a constant rate either directly into the mammary artery or into general circulation. Since a significant amount of isotope was adsorbed by catheter tubing (polyethylene, polyvinyl chloride, nylon and silicone rubber), the isotope was bound to goat albumen, autologous plasma, or, latterly, dissolved in 5% ethanolic saline and infused through P.T.F.E. tubing in which adsorption did not occur. During infusion the animals remained in their pens and samples of arterial and venous blood were taken. Progesterone was assayed by the technique previously described (Heap, 1964) and labelled progesterone was isolated simultaneously after adding a tracer amount of the same steroid labelled with a different isotope to assess procedural losses. Double isotope counting (^{14}C and ^3H) was performed by liquid scintillation spectrometry.

An example of a typical experiment is shown in Fig. 1 in which [7α - ^3H]-progesterone was infused at a constant rate for over $3\frac{1}{2}$ hr into the mammary artery of a goat 3 days after oestrus. During equilibrium which was reached after about 80 min, mammary extraction (arterial-venous/arterial $\times 100$) of progesterone was $63 \pm 6\%$ (mean \pm S.E.M., $n = 4$, 88–178 min after the start of the infusion), metabolic clearance rate (M.C.R. = infusion rate/concentration of labelled progesterone in arterial plasma) 2624 l./day, and production rate (M.C.R. \times concentration of progesterone in arterial plasma) less than 0.1 mg/day. In tissues removed at equilibrium, high concentrations of radiometabolites were found in liver and kidney mainly in a 'conjugated' form (butanol soluble, more than 7.27 m $\mu\text{c/g}$), whereas in mammary gland and milk the amounts of 'free'

* M.R.C. Scholar.

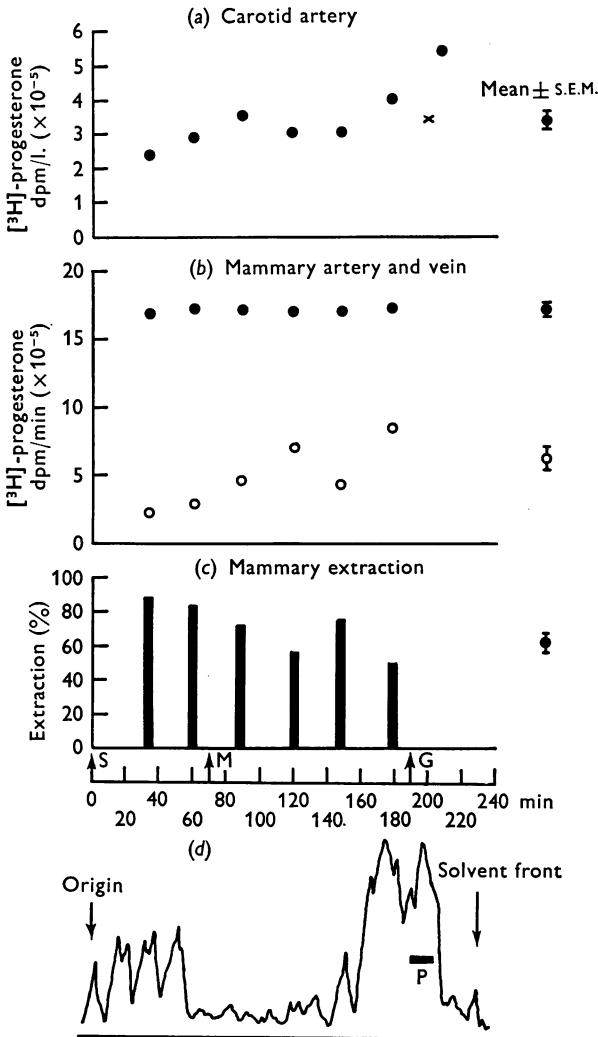

Fig. 1. Mammary metabolism of [7α - ^3H]-progesterone in a lactating goat under epidural anaesthesia (8-10 ml. 2% lignocaine) 3 days after oestrus. In this experiment the isotope was infused at a constant rate ($0.75 \mu\text{c}/\text{min}$) for 219 min; S = start of infusion, M = milked, G = general anaesthesia (pentobarbitone, 20 mg/kg i.v.). [7α - ^3H]-progesterone was measured in (a) carotid artery (\bullet) and mammary lymph (\times), and (b) mammary artery (\bullet) and vein (\circ). (c) Mammary extraction (%) of [7α - ^3H]-progesterone (arterial-venous/arterial $\times 100$). (d) Radiochromatogram scan of [7α - ^3H]-progesterone after 3 hr incubation with mammary tissue in Krebs-Ringer bicarbonate solution, pH 7, with added glucose and acetate (2 mg/ml.) and gassed with 95% $\text{O}_2/5\%$ CO_2 . Thin layer chromatography of a lipid extract was performed in the solvent system, benzene/ethyl acetate, 40/60. P = authentic progesterone. dpm, disintegrations per minute.

(ether soluble) and 'conjugated' metabolites were similar (about 1.14 m μ c/g). Incubations of mammary minces taken from the same goat indicated that in 3 hr there was an appreciable metabolism of progesterone (Fig. 1d) but relatively little metabolism of oestradiol, dehydroepiandrosterone, dehydroepiandrosterone sulphate or androstenedione.

The results of further experiments in four goats during the oestrous cycle and in pregnancy have also shown that there is a significant mammary extraction of progesterone which is rapidly metabolized with only a small accumulation of the steroid or its metabolites in mammary tissue.

REFERENCES

- HEAP, R. B. (1964). *J. Endocr.* **30**, 293-305.
HEAP, R. B. & LINZELL, J. L. (1966). *J. Endocr.* **36**, 389-399.

Implantation of the blastocyst in the pig

By J. S. PERRY. *A.R.C. Institute of Animal Physiology, Babraham, Cambridge*

The blastocysts become spaced along the length of the uterine lumen before their great elongation 12-13 days after fertilization. The uterine epithelium is modified where it is in contact with the trophoblast and a dense network of capillaries is formed immediately below it. Actual attachment is at first confined to relatively minute areas. Elsewhere, the outer surface of the trophoblast, as seen by electron microscopy, bears many long slender processes. These extend into the uterine lumen and have no intimate contact with the uterine epithelium; the luminal border of the latter is brush-like. By the 18th day the trophoblast cells are firmly locked against this border. By this time they have developed a relatively elaborate structure and their cytoplasm contains numerous vacuoles, apparently related to the absorption of material directly from the uterine epithelium. The latter has a prominent basement membrane which, up to this time, is not penetrated by maternal capillaries.

Perfusion of the sheep liver

By R. D. BURTON, I. R. FLEET, J. L. LINZELL and B. P. SETCHELL.
A.R.C. Institute of Animal Physiology, Babraham, Cambridge